



# SAILOR-12A

## 12.1" Full IP67 Sunlight Readable Panel PC

- Fully IP67 Water Proof Sealed

The system designed around robust waterproof enclosure and connectors could completely withstand harsh environment applications.

- Fanless System

An on-board 1.6GHz Intel® Atom™ Processor N270 CPU ensures low power requirements. Aluminum die-casting enclosure replaces the fan as it helps the PPC dissipate heat.

- Sunlight Readable

Equipped with 1000 nits super high brightness panel allows clear readability under outdoor environment. (400 nits typical brightness version is also available.)

- CAN-Bus interface especially for automotive applications

- WiFi 802.11 b/g/n Support



**Full IP67**  
Up to 1 meter  
of submersion



# SAILOR-12A 12.1" Full IP67 Panel PC

The rugged SAILOR-12A panel PC based on Intel's Atom processor is designed in a very robust and waterproof (IP 67/NEMA 6) in aluminum housing. Withstanding even the highest demands of all-day field use, and protected against shock and vibration permitting extremely flexible integration into a wide variety of applications, such as: avionics, military, marine, mining, industrial...etc.



## Features:

- 12.1" 1000 nits super high brightness TFT LCD available
- IP67 (NEMA 6) fully-enclosed aluminum die casting enclosure and IP67 waterproof lockable I/O
- Fanless system integrated with Intel Atom N270 1.6G processor for ultra Low voltage
- Supports one 2.0 GB (max.) 400/533 MHz DDR2 SO-DIMM
- Built-in internal WiFi antenna supports 802.11 b/g/n high standard
- One Compact Flash® Type II socket
- CAN-Bus interface for automotive applications
- Ambient light sensor detects ambient light for automated screen adjustments to optimize viewing. (Advanced Deep Dimming to Black for sunlight readable model)
- Touch Screen
- Standard VESA 75/100 compliance
- Panel mounting support

Ambient Light Sensor

Invisible Antenna Inside

System Power On/Off

M12 Waterproof Connectors

VESA75/75VESA100/100

Panel Mounting Holes

OSD Adjustment:

- LCD On/Off
- Brightness Up
- Brightness Down
- Speaker Volume Up
- Speaker Volume Down
- Ambient Light Sensor On/Off



## Rugged panel PC based on Fanless Intel Atom processor

SAILOR-12A using 45 nm Intel® Atom™ processor with frequencies up to 1.6GHz, the intelligent display computer is fan-less and can be used in harsh and safety-critical applications in transport, avionics, engineering or industrial automation.

### Passmark Performance

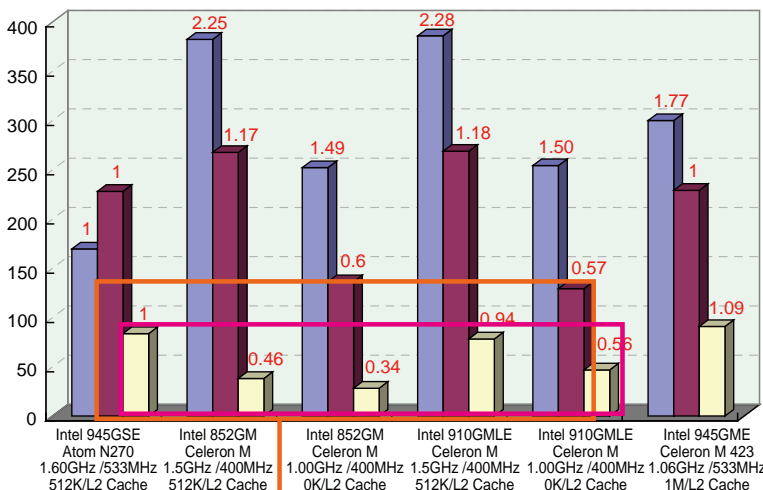

Better graphic performance is excellent for: kiosk, self-service terminal, and digital signage applications.



Evaluating 3D mark performance with different generation CPU and chipset combination, Intel® Atom™ processor is the best solution for low power consumption and better graphic performance choice.

# IP67 Fully-Enclosed Design

The SAILOR-A12 is designed by front sealing and test in the certified house chamber under UL's witnessed Test Data Program (TDP). IEI is following the IP67 standard testing procedures, This full IP67 touch monitor provides full IP67 protection including connectors, cables and Touch.

## [ IP67 ] Dust-Tight

### First Digit



The first digit indicates the level of protection that the enclosure provides against access to hazardous parts

Level		Effective Against
6		No ingress of dust; complete protection against contact

## [ IP67 ] Temporary immersion under water 1m

### Second Digit

Protection of the equipment inside the enclosure against harmful ingress of water

Level		Effective Against
6		Water projected in powerful jets against the enclosure from any direction shall have no harmful effects
7		Ingress of water in harmful quantity shall not be possible when the enclosure is immersed in water under defined conditions of pressure and time (up to 1m of submersion)

*Sealing enclosure with all sides of IP67 !*



## Strict Testing Standards!

### UL 50 Certificate

IEI in house water resistance chamber is approved by UL organization commonly recognized in North America.

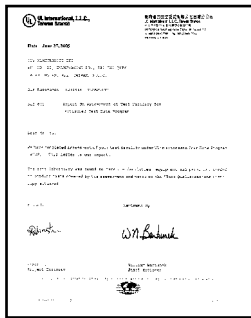

### Optional IP67 Cables

We provide these hard-to-find cables optional to save your time searching and budget.

#### 3 Meter Long Cable Length

Customized cables exceeding typical 1.8 m long to provide more usage flexibility.

#### Extra Durability

These waterproof cables can prevent costly repairs sometimes necessary when contaminants such as water and dust destroy standard connectors.

## Fully Watertight Connectors!



1. GbE LAN
2. RS-232
3. RS-232/422/485
4. CAN bus and Audio line out
5. Two USBs
6. POWER Adapter

*Economical M12 connectors with self-locking threaded joint*



# Sunlight Readable

## • Super High Brightness

SAILOR-12ASR

(Sunlight Readable Model) has greatly improved luminance through edge lighting to achieve super high brightness (up to 1000 cd/m<sup>2</sup>).

## • Low Reflection through AR (Anti-Reflection) Technology

Outdoor applications in daylight or other bright environments require technology that can suppress surface reflection. SAILOR-12ASR sunlight readable model offer special AR (anti-reflection) surface treatment to prevent reflection, which ensures excellent visibility in daylight conditions.

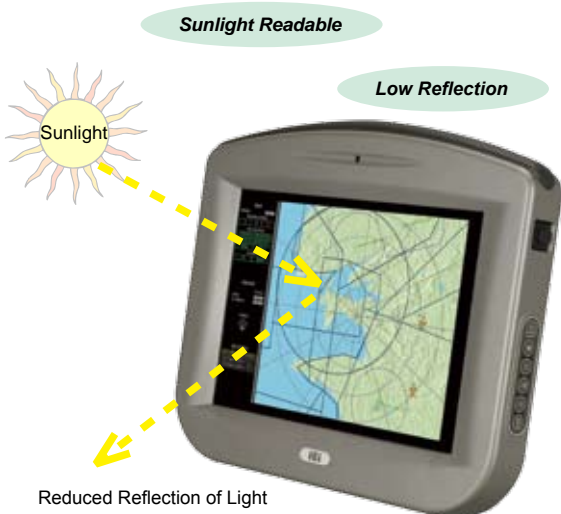

**Super High Brightness: 1000 nits**  
**High Contrast: 700:1**  
**Wide Viewing Angle: 60/60 (R/L) 45/75 (U/D)**

## • Ambient Light Sensor

The SAILOR-12A built in the ambient light sensor in front of the panel to automatically detect the amount of light in the viewing environment and auto-adjusts the brightness of the screen.

### Benefits:

- Avoid eye strained and tired, to provide comfortable viewing
- Power consumption saving
- Extend lamp lifetime



### Day Mode:

Adjust to maximum 1000 nits  
 Sunlight Readable automatically

Panel brightness auto-adjustment  
 depends on the ambient light  
 amount to save the system power

### Night Mode:

Adjust to acceptable brightness auto-  
 matically in a insufficient light ambient

## Applications:



Outdoor KIOSK



Ultra Bright Marine Display

# Endless Wireless Connection

The SAILOR-12A series featuring high speed WiFi IEEE 802. n protocol which builds on previous 802. standards by adding multiple-input multiple-output (MIMO) and 40 MHz operation to the physical (PHY) layer. MIMO uses multiple transmitter and receiver antennas to improve the system performance.



27 times faster data transfer rate compare 802.11b

Protocol	Freq.	Thru.	Data	Range indoor	Range outdoor
802.11 a	(GHz)	(Mbit/s)	(Mbit/s)	(m)	(m)
a	5 GHz	23	54 Mbit/s	~35	~120
b	2.4 GHz	4.3	11 Mbit/s	~38	~140
g	2.4 GHz	19	54 Mbit/s	~38	~140
n	5 GHz and/or 2.4 GHz	74	300 Mbit/s (2 streams)	~70	~250

802.11b/g Wi-Fi, which gives you up to broadband-speed browsing and connectivity, compared to traditional wired LAN.

The benefits here:

- Simple configuration
- Without hinders worker movement
- Without lessens man-hour productivity
- Without additional purchase of proprietary cables for specific devices
- Without the barrier to space



## Benefit

- \* Half the size of Mini-PCI
- \* Higher bandwidth interface
- \* Rigid mechanical spec.



## 802.11a



Access to email, instant image and the Internet

## 802.11b/g



Streaming music Streaming video

## 802.11n



VoIP /Gaming /NAS

# CAN-Bus Automotive Applications

The SAILOR-12A is equipped with automotive applied CAN-Bus interface. The Control Area Network (CAN) is a serial bus system, originally developed by Bosch for use in automobiles, and now is increasingly being used for control in industrial and automotive applications

## Controller Area Network

- 1Mb/s data rate
- High reliability bus
- CAN is an open standard with many variants
- Is capable of providing real-time communication.

### CAN in cars and truck engine

- Networking controllers for engine timing, transmission, chassis and brakes.
- Networking components of chassis electronics and electronics which make the vehicle more comfortable. Examples of such multiple applications are lighting control, air-conditioning, central locking and seat and mirror adjustment.



Other Application Fields:



# Reliable Die-Casting Aluminum Chassis

These ruggedized LCD products are also designed for high reliability, shock and vibration tolerance, survival of high temperature, and corrosive environments. External materials like dust/ water can be very destructive to any type of equipment over time.

### Fanless and Completely Sealed Strong Housing

Sealed housing strictly avoids the water invasion and the rugged die-cast aluminum enclosure helps the need for using a fan as a heat dissipation device to minimize the troublesome overheating problem.

Fanless and Strong!

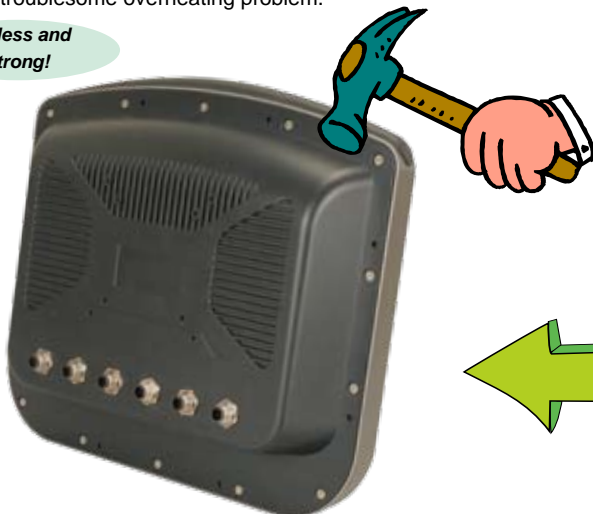

### Rigorous Shock/Vibration Test

Compliant with MIL-STD-810F shock and vibration protection, as well as offering IP67 water and dust proof front panel protection.

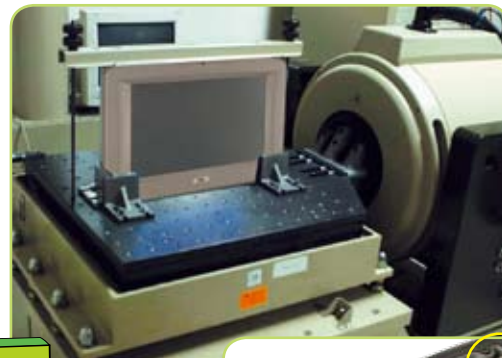

Operating Temperature: With on-board 1.6GHz Intel® Atom™ Processor N270  
-10°C~50°C

# Dedicated Applications

## • High Brightness Marine Panel PC

**CAN-Bus  
Transmission**

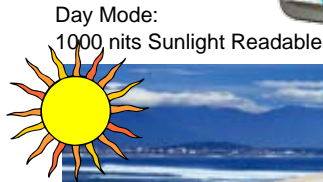
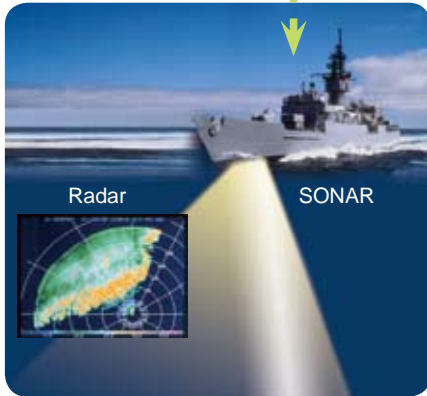

Night Mode:  
For power saving and navigation safety



**1000 nits  
Sunlight Readable !**

**0%~100% brightness control  
for Navigation Safety !**

We Offer:

- Transflective technology super high brightness 1000 nits enhance visibility
- Intel® ATOM Platform, Fanless Design
- Dimming keypad control backlight brightness from nearly 0% to 100%
- Ease of use front panel OSD control
- Enhanced shock and vibration resistance
- Touch Screen Capable
- Panel mounting support

## • Logistics and Warehousing

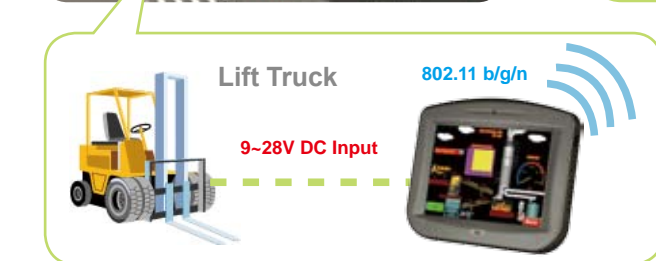
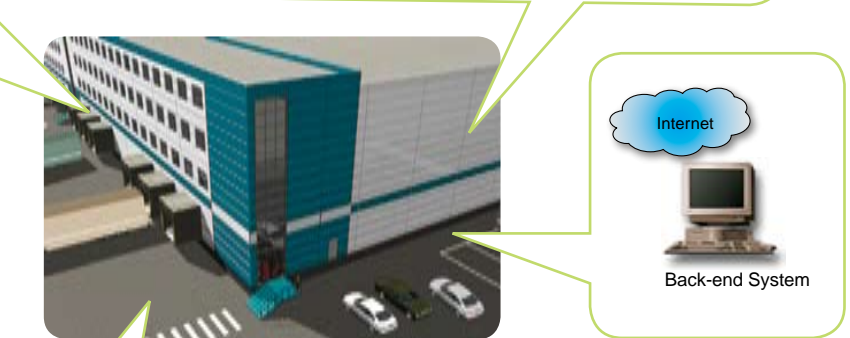

We Offer:

- Wireless functions can also be implemented via a PCIe mini card slot in
- combination with an internal antenna.
- Designed for automotive applications featuring built in CAN-Bus interface

## Specifications

Model		Sunlight Readable	Typical Brightness
		SAILOR-12ASR/M12	SAILOR-12A/M12
Display	LCD Size	12.1"	
	Max Resolution	1024 * 768	
	Brightness (cd/m <sup>2</sup> )	1000	400
	Contrast Ratio	700:1	500:1
	LCD Color	262K	262K
	Pixel Pitch (mm)	0.240mm(H) x 0.240mm(V)	
	Lamp Life Time (hrs)	50000	60000
Mainboard	CPU	N270 (Atom 1.6GHz)	
	Chipset	Mobile Intel 945GSE Chipset + ICH7M	
	RAM	1 x 200-pin SO-DIMM DDR2 400/533 MHz up to 2GB	
I/O Interface	1 x 5pin M12 connector for POWER Adapter		
	1 x 8pin M12 connector for two USB		
	1 x 5pin M12 connector for CAN bus and Audio line out		
	1 x 8pin M12 connector for UART RS-232/422/485		
	1 x 8pin M12 connector for UART RS-232		
	1 x 8pin M12 connector for GbE LAN		
Storage	IDE	1x CFII	
	HDD Drive Bay	1 x 2.5" SATA HDD bay	
Extension		1 x Wireless Lan Module (802.11 b / g / n) (internal Mini PCIe interface)	
Membrane Keypad Functions		LCD ON/OFF	
		Brightness Control	
		Volume Control	
		Auto dimming Control	
Environment	Mounting	VESA 75 /VESA 100	
	Dimensions (W x H x D) (mm)	345.3 mm x 300.4 mm x 77 mm	
	Operation Temperature (°C)	-10~50°C	
	N/G Weight	4.2 kg	
	IP Level	IP67 Sealed	
	Power Consumption	43W	32W
	Safety & EMI		CE / FCC/ CCC / CB

## Packing List

Item	Part Number	Q'ty	Specifications
Panel Mount Screws Pack	44013-030041-RS	1	
Power cable	32000-127500-RS	1	2000MM;16AWG;(A)wire;(B)WATERPROOF CONNECTOR
Utilities CD	7B000-000087-RS	1	
Touch Pen	XTR104-0002-RS	1	



## Options

Model	SAILOR-12A/M12
Wall mounting kit	AFLWK-12
Rack mounting kit	SAILORRK-12
ARM	ARM-11-RS / ARM-31-RS
Stand	STAND-A12 / STAND-100-RS / STAND-150-RS
OS: WinCE 6.0	SAILORCF-12-ATOM-CE060-R10
OS: WinXPE	SAILORCF-12-ATOM-XPE-R10
OS: Linux	SAILORCF-12-ATOM-LNX-R10

## Optional Cables

Item	Part Number	Specifications
USB cable	32000-123201-RS	3000MM;24AWG;(A)USB A TYPE 4PIN FEMALE X2;(B)WATERPROOF CONNECTOR
RJ45 cable	32000-123301-RS	3000MM;24AWG;(A)RJ45 PLUG 8P8C ;(B)WATERPROOF CONNECTOR
COM port cable	32000-123401-RS	3000MM;24AWG;(A)D-SUB 9P MALE ;(B)WATERPROOF CONNECTOR
CAN bus and Audio line-in cable	32000-124101-RS	3000MM;24AWG;(A)D-SUB 9P FEMALE;(B)WATERPROOF CONNECTOR
Water-proof Power Adapter	63000-CLG6012IC-RS	Input:AC:90V~264V;Output:12V/5A;60W;WATERPROOF CONNECTOR 5P



## Ordering Information

Part Number	Description
SAILOR-12A-ATOM-N270/WT-R/1GB-M12-R10	12.1" 400 cd/m <sup>2</sup> XGA fanless panel PC with Intel ATOM N270 CPU 1.6GHzU,802.11 b/g/n wireless module,touch screen,1GB DDR2 553MHz,M12,RoHS
SAILOR-12ASR-ATOM-N270/WT-R/1GB-M12-R10	12.1" 1000 cd/m <sup>2</sup> XGA fanless panel PC with Intel ATOM N270 CPU 1.6GHzU,802.11 b/g/n wireless module,touch screen,1GB DDR2 553MHz,M12,RoHS

## Dimensions

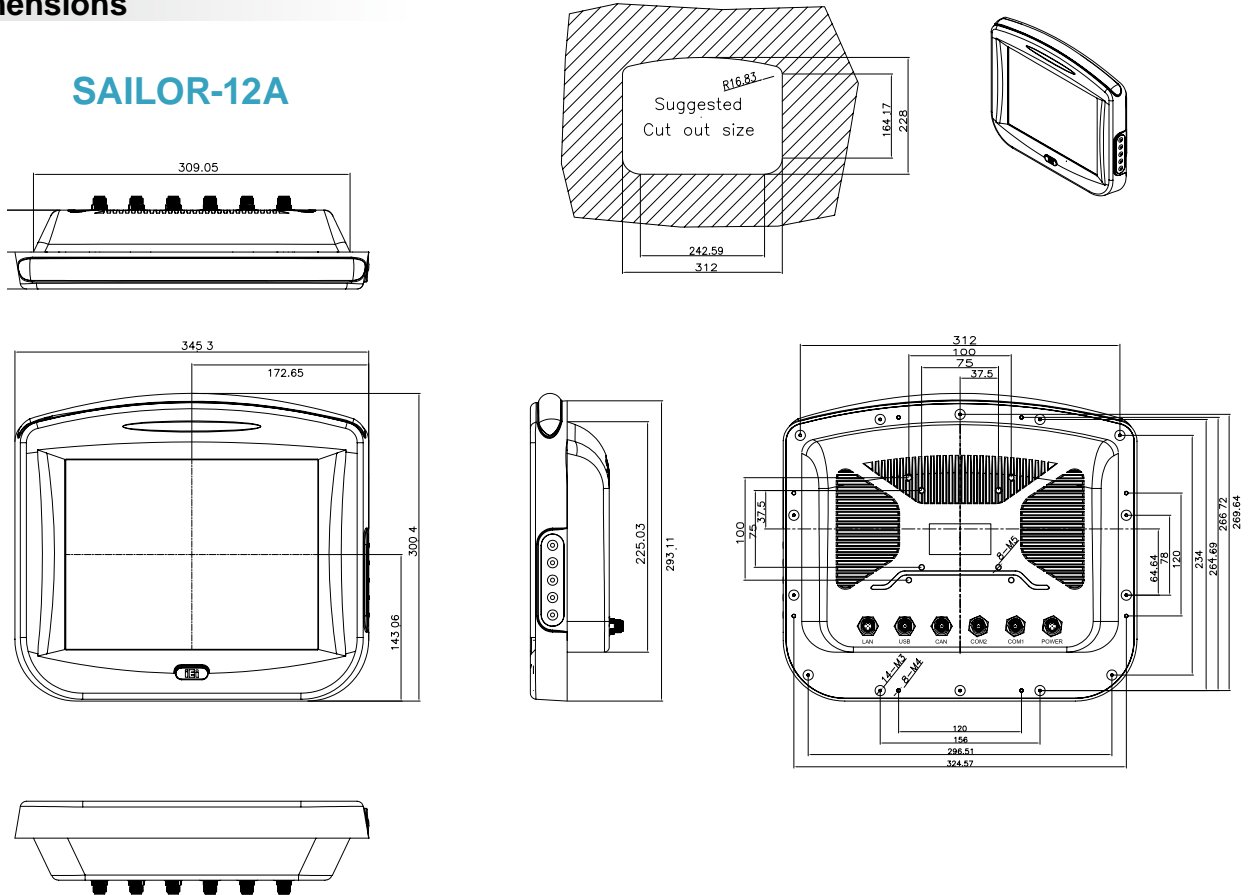

### Headquarters

威強工業電腦股份有限公司 IEI Technology Corp.

No. 29, Jhongsing Rd., Sijhih City, Taipei County, 221, Taiwan  
 TEL : +886-2-86916798 FAX : +886-2-66160028  
 sales@ieiworld.com www.ieiworld.com

### America

IEI Technology USA Corp.

168 University Parkway, Pomona, CA 91768  
 TEL : +1-909-595-2819 FAX : +1-909-595-2816  
 sales@usa.ieiworld.com www.usa.ieiworld.com

### China

威強工业电脑 IEI Technology (Shanghai) Co., Ltd.

上海市闵行区宜山路 1728 号 3 楼。  
 3F No. 1728 Yi-Shan Road, Min-Hang, ShangHai, China  
 TEL : +86-21-3462-7799 FAX : +86-21-3462-7798,3462-7797  
 sales@ieiworld.com.cn www.ieiworld.com.cn